

符合RoHS环保要求

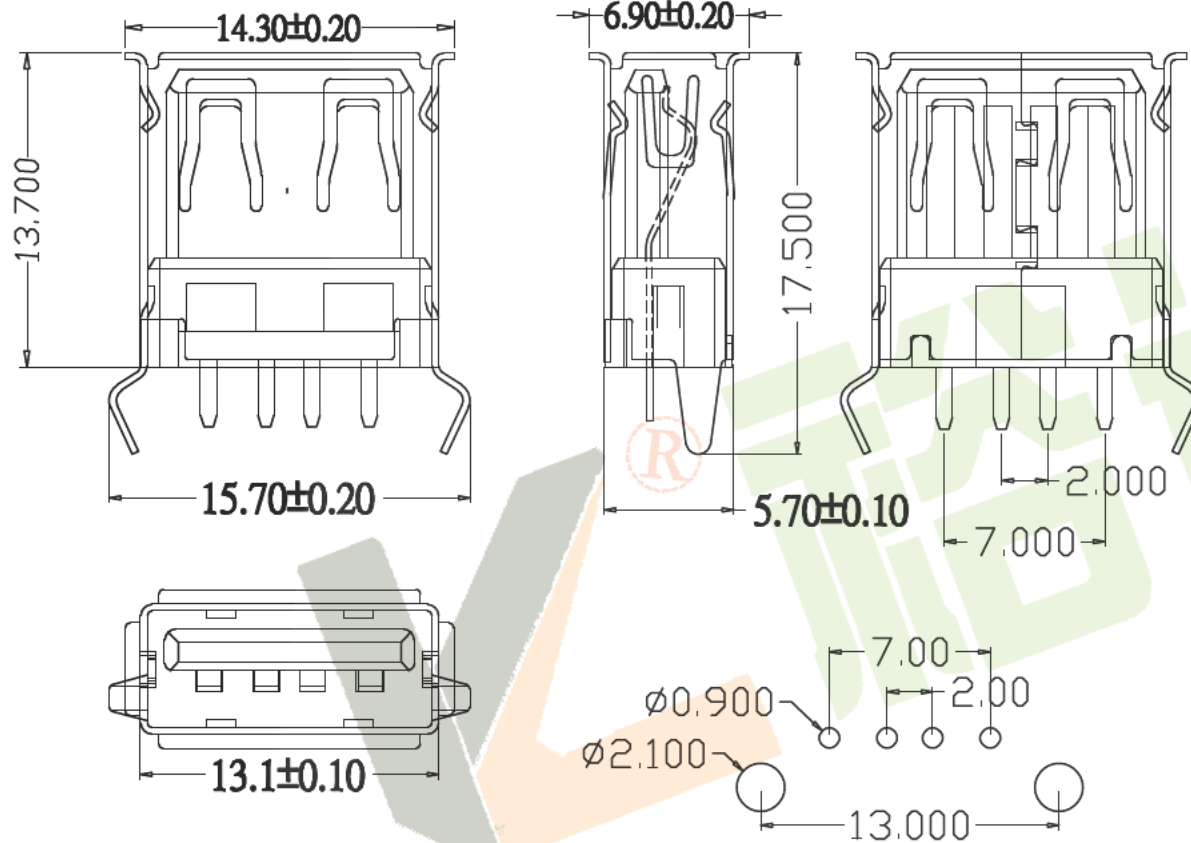

规格说明: Specifications:

电气特性: Electrical:

1. 额定电流: Current Rating
1.5A/contact terminal
 2. 额定电压: Voltage Rating
30V DC
 3. 接触阻抗: Contact Resistance
30 milliohms MAX
 4. 耐电压: Dielectric Withstanding Voltage:
500 V AC AT Sea Level
 5. 绝缘阻抗: Insulation Resistance:
1000MEGA ohms MIN
-
1. 插拔力: Connector Mate and Unmate Force
Mate force: 3.57kgf(MAX)
Unmate force: 1.02kgf(MIN)
 2. 端子保持力: Terminal Retention
1.0kgf(MIN)

原材料: Material:

1. 塑胶: Housing:
High Temperature Thermoplastics,
2. 端子: Contact: Copper Alloy C2680
3. 外壳: Shell: Copper Alloy C2680/SPCC

电镀: Finish:

1. 端子: Contact: Plated Gold in Mating Area
Tin On Solder Tails

端子四周镀50U”(MIN)锡, 镀金区域镀100-200U”镀金1U”

2. 外壳: Shell:
铜壳四周镀80U”(MIN)锡

Nickel Plating

<p>产品图 PRODUCT CHART DWG</p>		<p>深圳市裕诚电子有限公司 SHENZHEN YUCHENG ELECTRONICS CO., LTD</p>			
<p>公差一览表 TOLERANCE UNLESS OTHERWISE</p>		<p>单位 UNITS</p>	<p>制图 DRAWING</p>	<p>陈雅</p>	<p>制图料号 PRODUCT PART NO</p>
.X	±0.15	X	±5'	比例 SCALE	1:1
.XX	±0.05	.X	±2'	审核 CHKD	洪章波
.XXX	±0.02	.XX	±1'	日期 DATE	2016.2.5
www.ycelectron.com		核准 APPD	魏杰	产品名称 PRODUCT NAME	USB-Z1324-137
		角法 VIEW		版本 VER	A0

符合RoHS环保要求

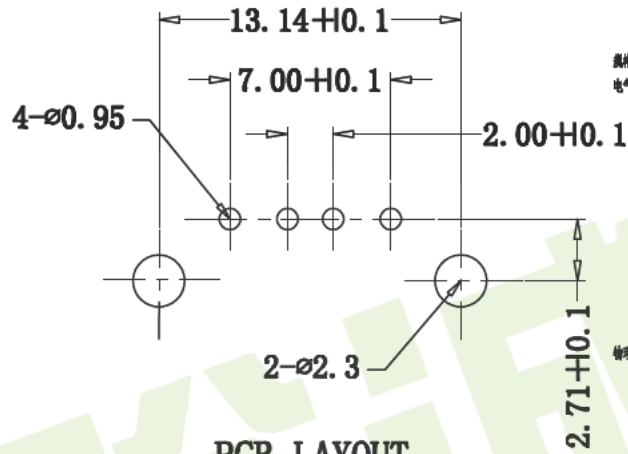
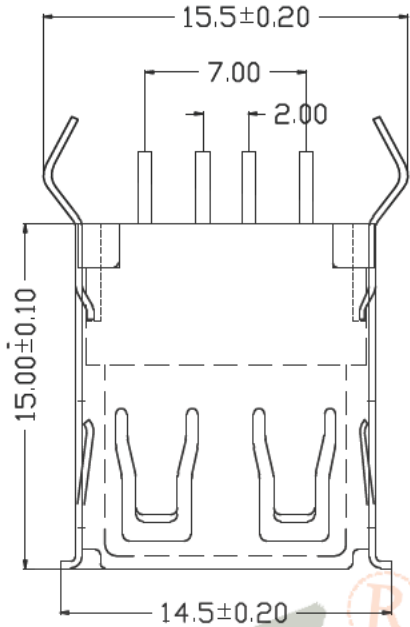
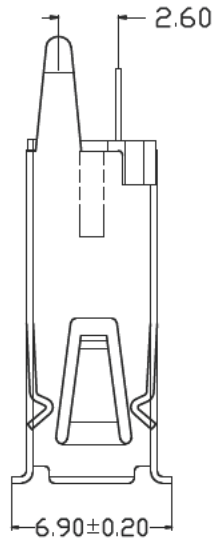

PCB LAYOUT

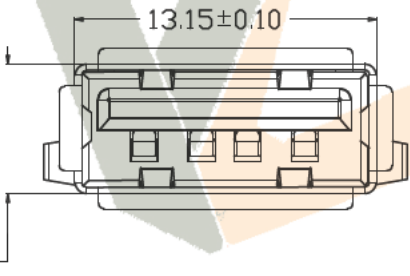

规格书 Specifications:

电气特性 Electrical:

- 额定电流: Current Rating 1.5A/contact terminal
- 额定电压: Voltage Rating 30V DC
- 接触电阻: Contact Resistance 30 milliohms MAX
- 耐压: Dielectric Withstanding Voltage: 500 V AC AT Sea Level
- 绝缘电阻: Insulation Resistance: 1000MEGA ohms MIN

物理性能 Mechanical:

- 插拔力: Connector Mate and Unmate Force
Mate force: 3.57kgf(MAX)
Unmate force: 1.02kgf(MIN)
- 端子保持力: Terminal Retention 1.0kgf(MIN)

原材料: Material:

- 壳体: Housing: 高温热塑性塑料, PBT 白色/黑色
- 端子: Contact: 铜合金 C2680
- 外壳: Shell: 铜合金 SPCC

电镀: Finish:

- 端子: Contact: 插接区镀金, 焊脚镀锡
- 外壳: Shell: 镀镍

产品图 PRODUCT CHART DWG		 深圳市裕诚电子有限公司 SHENZHEN YUCHENG ELECTRONICS CO., LTD							
公差一览表 TOLERANCE UNLESS OTHERWISE		单位 UNITS	MM	制图 DRAWING	陈雅	制图料号 PRODUCT PART NO.	USB-Z1324-151		
.X	±0.15	X	±5'	比例 SCALE	1:1	审核 CHKD	洪章波	产品名称 PRODUCT NAME	15.0卷边弯脚
.XX	±0.05	.X	±2'	日期 DATE	2016.2.5	核准 APPD	魏杰	角法 VIEW	 版本 VER
.XXX	±0.02	.XX	±1'	www.ycelectron.com				 版本 VER	A□

符合RoHS环保要求

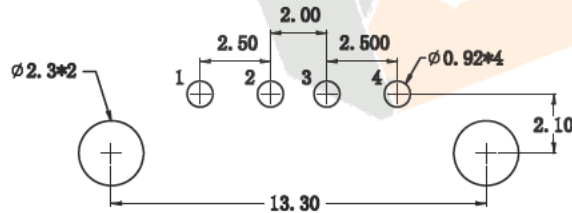
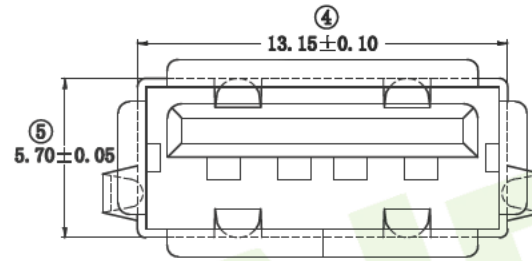
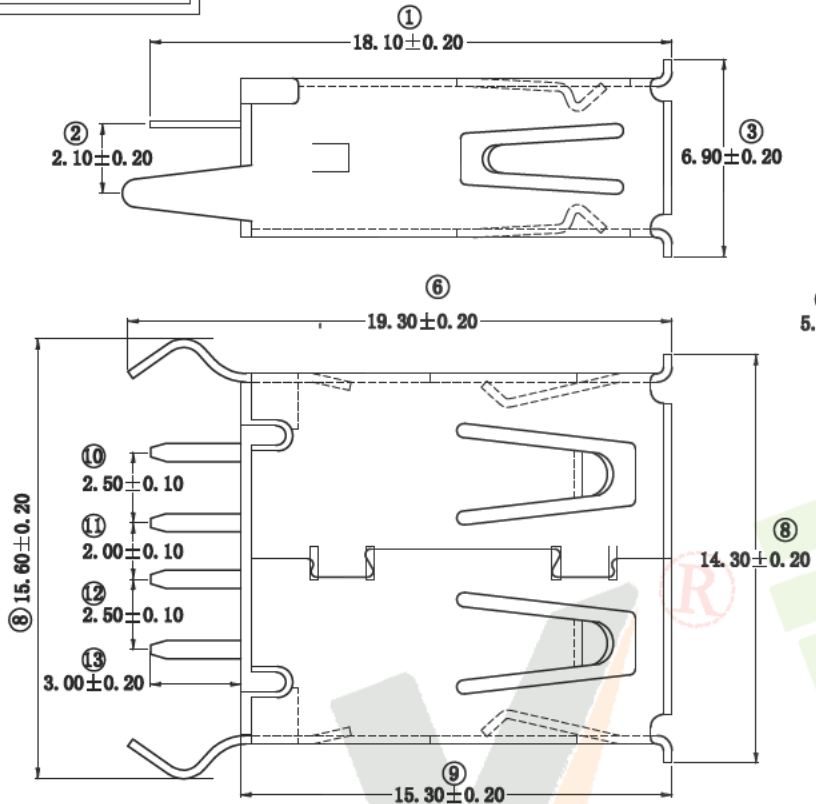

规格说明: Specifications:

电气特性: Electrical:

1. 额定电流: Current Rating
1.5A/contact terminal
2. 额定电压: Voltage Rating
30V DC
3. 接触阻抗: Contact Resistance
30 milliohms MAX
4. 耐电压: Dielectric Withstanding Voltage:
500 V AC AT Sea Level
5. 绝缘阻抗: Insulation Resistance:
1000MΩ ohms MIN

物理性能: Mechanical:

1. 插拔力: Connector Mate and Unmate Force
Mate force: 3.75kgf (MAX)
Unmate force: 1.02kgf (MIN)
2. 端子保持力: Terminal Retention
1.2kgf (MIN)

原材料: Material:

1. 塑胶: Housing:
High Temperature Thermoplastics,
UL 94V-0 PBT/LCP White/Black
2. 端子: Contact: Copper Alloy C2680
3. 外壳: Shell: Copper Alloy C2680/SPCC

电镀: Finish:

1. 端子: Contact: Plated Gold in Mating Area
Tin On Solder Tails
2. 外壳: Shell:
Nickel Plating

<p>产品图 PRODUCT CHART DWG</p>		<p>深圳市裕诚电子有限公司 SHENZHEN YUCHENG ELECTRONICS CO., LTD</p>				
<p>公差一览表 TOLERANCE UNLESS OTHERWISE</p>		<p>单位 UNITS</p>	<p>制图 DRAWING</p>	<p>制图 陈雅</p>	<p>制图料号 PRODUCT PART NO</p>	
.X	±0.15	X.	±5°	MM	洪章波	USB-Z1324-153
.XX	±0.05	.X	±2°	比例 SCALE	魏杰	15.3卷边弯脚
.XXX	±0.02	.XX	±1°	日期 DATE	2016.2.5	角法 VIEW
<p>www.ycelectron.com</p>		<p>核准 APPD</p>	<p>日期 DATE</p>	<p>核准 APPD</p>	<p>版本 VER</p>	<p>角法 VIEW</p>