

Circuit Diagram

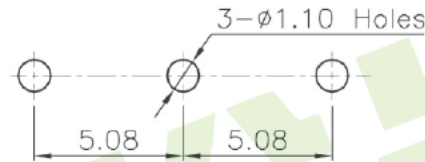

P.C.B layout

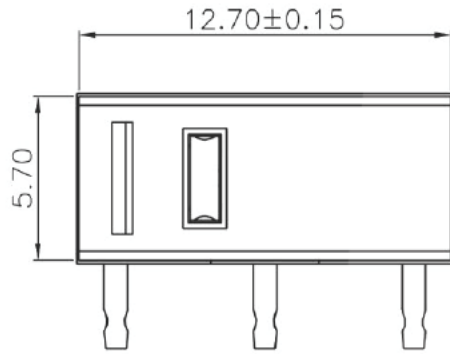
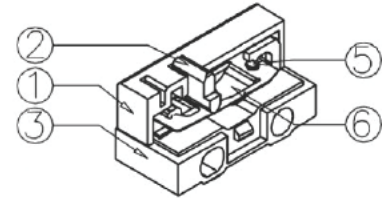
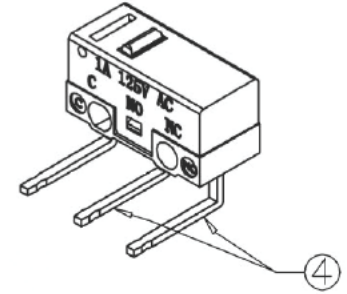
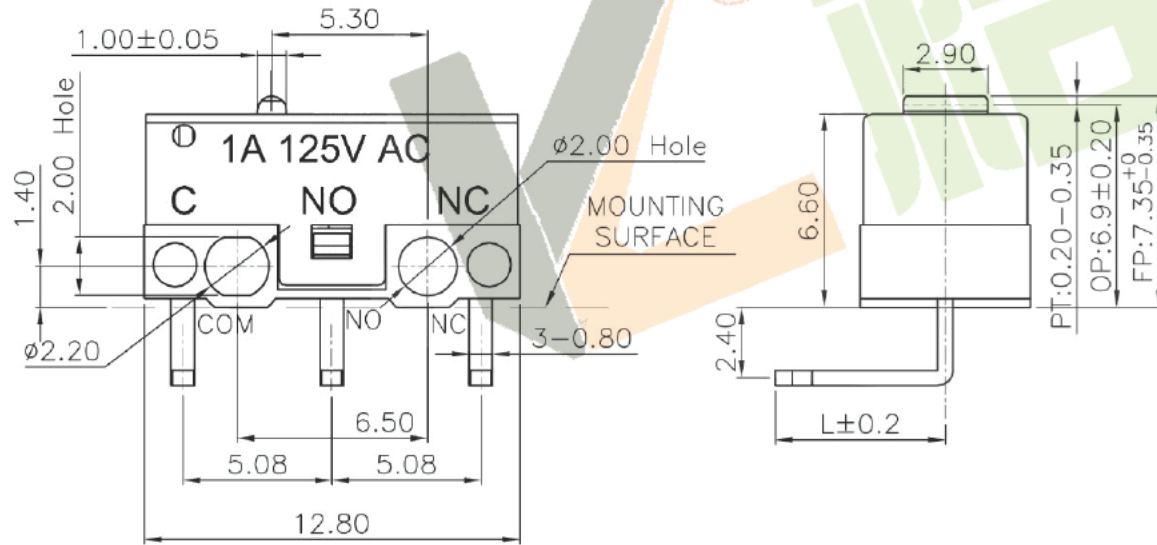

NOTE:

- 1.Rating:DC30V 0.1A
- 2.OP:6.90±0.20
- 3.Operating force:70±15gf
- 4.Mechanical Life:1,000,000

ITEM	PART NAME	TER'NO.	QTY.	MATERIAL	FINISHING	REMARK
⑥	Shrapnel	—	1	Beryllium Copper	—	—
⑤	Contact	—	1	Ag	—	—
④	Terminal	—	3	Brass(0.52t)	Plating silver	—
③	Housing	—	1	PBT	White	—
②	Knob	—	1	POM	White	—
①	Cover	—	1	PBT	Black	—

APPROVALS		DATE		深圳市裕诚电子有限公司 SHENZHEN YUCHENG ELECTRONICS CO.,LTD		
DRAWN	J.X.Zhang	2013/11/6				
CHECKED				WEBSITE	www.ycelectron.com	
APPROVALS				PART NO.	M7-1130Z	
TOLERANCES ARE			30~0L F: ±0.30	ANGLE	UNIT: mm	SCALE: 1:1
			10~30 ±0.20	±2'	DRAWING NO.	PROJ:
			5~10 ±0.15			
			~ 5 ±0.10			

ECN NO.	REV.	DATE.	DESCRIPTION.	CHANGE.	CHECK.	APPRO.
	A		NEW			

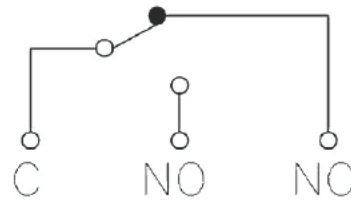
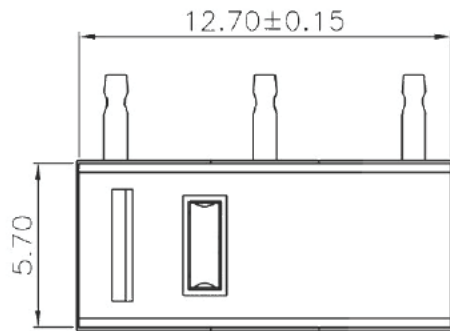

Circuit Diagram

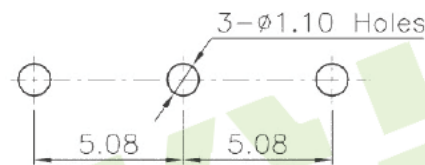
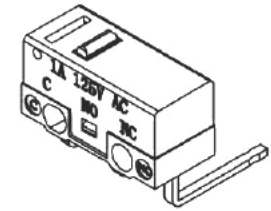

P.C.B layout

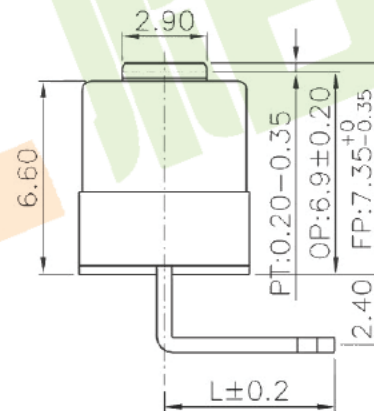
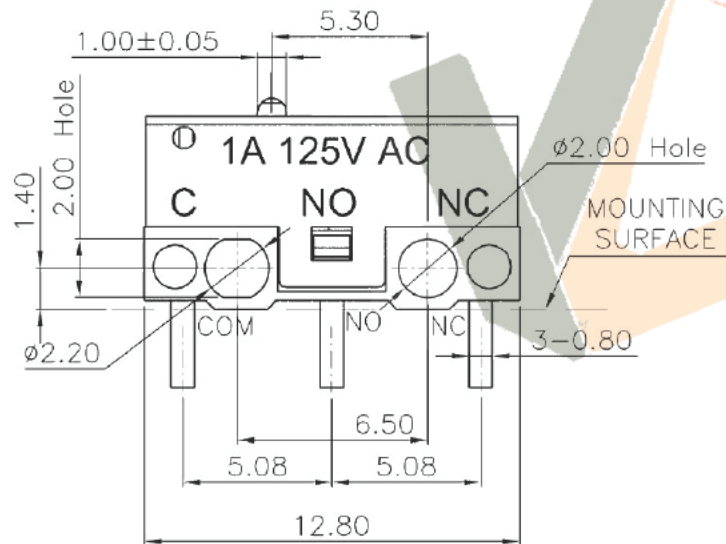
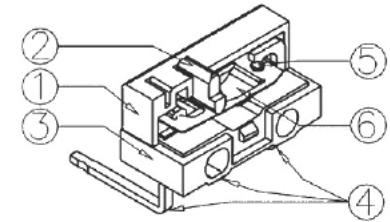

NOTE:

- 1.Rating:DC30V 0.1A
- 2.OP:6.90±0.20
- 3.Operating froce:70±15gf
- 4.Mechanical Life:1,000,000

①	Shrapnel	—	1	Beryllium Copper	—	—
②	Contact	—	1	Ag	—	—
③	Terminal	—	3	Brass(0.52t)	Plating silver	—
④	Housing	—	1	PBT	White	—
⑤	Knob	—	1	POM	White	—
⑥	Cover	—	1	PBT	Black	—
ITEM	PART NAME	TER'NO.	QTY.	MATERIAL	FINISHING	REMARK

APPROVALS		DATE		深圳市裕诚电子有限公司 SHENZHEN YUCHENG ELECTRONICS CO.,LTD		
DRAWN	J.X.Zhang	2013/11/6				
CHECKED				WEBSITE	www.ycelectron.com	
APPROVALS				PART NO.	M7-1130Z	

_____	A	_____	NEW	_____	_____	_____
ECN NO.	REV.	DATE.	DESCRIPTION.	CHANGE.	CHECK.	APPRO.
			TOLERANCES ARE	30~0.1	±0.30	ANGLE
				10~30	±0.20	UNIT: mm
				5~10	±0.15	SCALE: 1:1
				~ 5	±0.10	±2'
			DRAWING NO.			PROJ.
					SHEET 1 OF 1	